

19" NETbox HOME Wall Mounting Cabinets



19" NETbox HOME Wall Mounting Cabinets

Family

NETbox HOME Residential Cabinet Features, Construction Details:

Monoblock U shaped construction provides better stability.

The NETbox Home Wall Mounting is for that situation where quick access to the equipment is of primary importance. It is designed to house 19" standard mounting devices.

The NETbox Home Wall Mounting Cabinet offers a highly cost-effective and assembly-friendly solution for numerous applications in the field of network technology and electronics.

The NETbox Home Wall Mounting Cabinet front door is integrated with decorative 2,5 mm thickness aluminium extruded frames, full length smoked, shatterproof, antistatic, 4,0 mm thickness glass with single point locking barrel lock.

Aluminium extruded frame carry an decorative PVC Stripes charming the attraction, Anthracite Grey for RAL 7035 Light Grey Cabinets and Light Grey for RAL 9005 Black cabinets. However based on customer wishes and/or market demands Lande offers multiple color option to customers.

The NETbox Home Wall Mounting Cabinet because of the intend of decoratively fitting to environment of your living areas, the cabinet has been integrated with highly modern, art fragrant 0,5 mm thickness PVC decoration on top and bottom provision of the glass door.

Includings:

- Complete with 2 ea. 19" equipment mounting rail, with automated silk-screen U numbering, removable in depth.
- Grounding studs are fixed on to main body and front door frame for grounding continuity, shipping configuration includes the yellow/green grounding wires with nuts.
- Reinforced 2,5 mm thickness aluminium extruded housing for glass door with left and right metal frames, lockable, removable complete with barrel locking system.
- Reversible front door left to right or reverse.
- Material thickness: 1,2 mm.
- 8-12 micron zinc plated mounting rails t: 1,5 mm.
- Self locking type sturdy structure and rugged, monoblock frame.
- Multipurpose usage.

Passive ventilation punched slot holes in front of top and bottom case.

Cables access:

- Multiple cable entry points on top and bottom with 6 knock-out holes at 1" size and additional micro-joint break down cable entry hole at 452 mm size for mass cable entry needs.

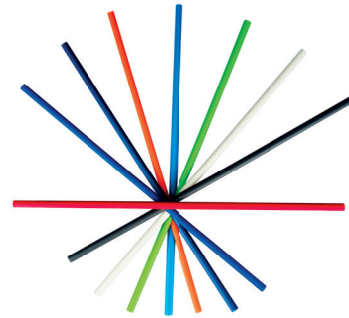

19" NETbox HOME Wall Mounting Cabinets

Width: 600 mm
Depth: 150/300 mm

Load Capacity: 80 kgs.

U Height: 6U, 9U, 12U

Standards and Compliances:



**ISO 9001
Quality Management System**

EN 61587-1
Mechanical Structures for
Electronic Equipment

EN IEC 297-1, 19" Mounting
EN IEC 297-2 Overall Cabinet Dimensions

EN/IEC 60529- IP20 Ingress Protection
performance

EN/IEC 62262- IK07 Mechanical
Impact Resistance

EIA/ ECA-310 (D/E) 19" 482,6 mm
and U 44,45 mm Height Sizing



CE conform to
EN 60950-1
Information Technology
Equipment, Safety,
Part-1: General Requirement

EN IEC 62368-1 Audio/Video, Information
and Communication Technology Equipment
Part 1: Safety requirements



UL listed to
UL 2416, Outline of Investigation for
Audio/Video, Information and
Communication Technology Equipment
Cabinet, Enclosure and Rack
Systems; UL 60950-1 and CSA C22.2
NO. 60950-1-07, Information Technology
Equipment Safety
Part 1: General Requirements



Environment Friendly;
ISO 14001 Environmental
Management System
RoHS compliancy
%100 Recyclable Material

Standard Colors:

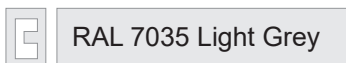

NETbox Home Series Wall Mounting Networking Enclosures, with 19" w:600 mm and d:150/300 mm physical sizes, with less depth need in environmentally fit especially for residential applications, and 3 different height, gives a wide selection chart for users.

All Lande NETbox Home Wall cabinets are being delivered as a single piece pre-assembled enclosure, with standard factory settings.

For decoratively fitting to environment of your living areas, the cabinet has been integrated with highly modern, art fragrant parts and accessories.

19" NETbox HOME Wall Mounting Cabinets

Width: 600 mm
Depth: 150 mm

Construction Drawing

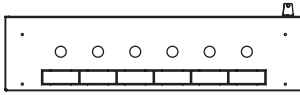

Bottom view

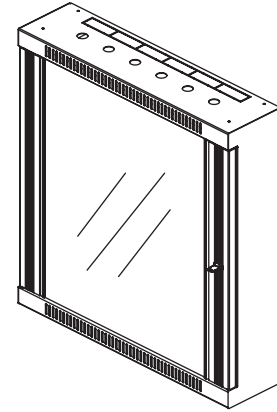

Isometric view

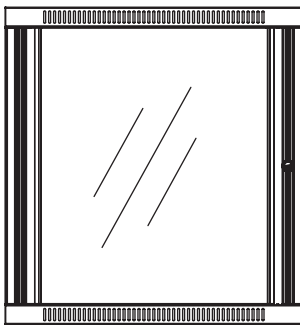

Front view



Side view

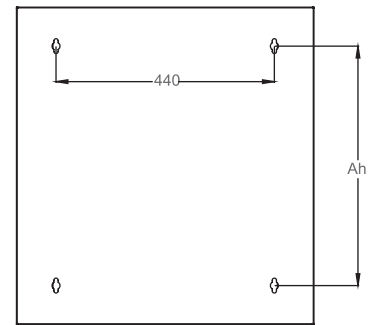

Rear view

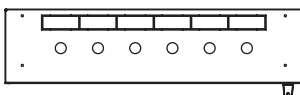

Top view

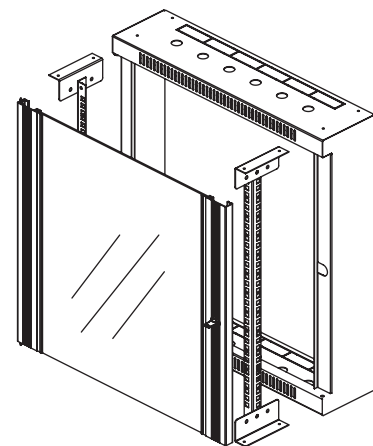

Exploded view

19" NETbox HOME Wall Mounting Cabinets

Width: 600 mm
Depth: 150 mm

Construction Drawing

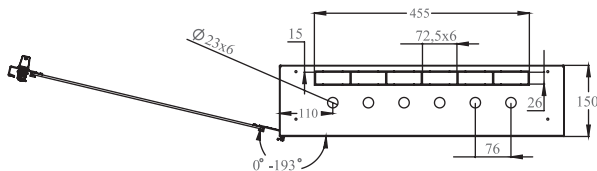

Front door
opening angle

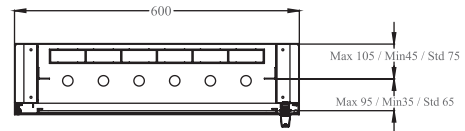

Max/Std/Min
Equipment mounting
distance

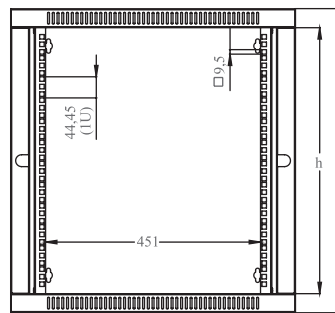

Dimensions in
width and height

19" NETbox HOME Series Wall Mounting Cabinets W= 600 mm D= 150 mm

*Product Number	Product Description	Size WxDxH mm.	h Size in U	h in mm.	H mm, overall	Ah Wall Mounting h mm.	Width Overall mm.	Width Rail to Rear Door	Depth Overall mm.	Depth Shipping Conf. Rail to Rear Panel mm	QTY IN PACKAGE	PACKING DIMENSIONS WxDxH mm.	Standard NET Weight of Product kgs.	Gross Weight of Product kgs.	QTY IN PALLET	PALLET DIMENSIONS WxDxH mm.	Pallet Weight kgs.
LN-RS06U6015-LG	6U 19" Wall Mounting Cabinet W=600 mm D=150 mm	600x150x373	6U	267	373	215	600	19"	150	75	1	620x170x395	7,5	8,5	60	1000x1320x2460	535
LN-RS09U6015-LG	9U 19" Wall Mounting Cabinet W=600 mm D=150 mm	600x150x506	9U	400	506	349	600	19"	150	75	1	620x170x525	10	11	48	1000x1250x2160	548
LN-RS12U6015-LG	12U 19" Wall Mounting Cabinet W=600 mm D=150 mm	600x150x640	12U	533	640	482	600	19"	150	75	1	620x170x660	13	14,5	24	680x1250x2280	363

*CC= LG for Light Grey RAL 7035 & BL for Black RAL 9005 for customers to define while ordering.

19" NETbox HOME Wall Mounting Cabinets

Width: 600 mm
Depth: 300 mm

Construction Drawing

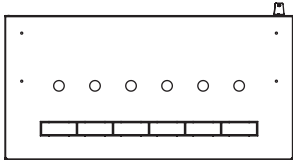

Bottom view

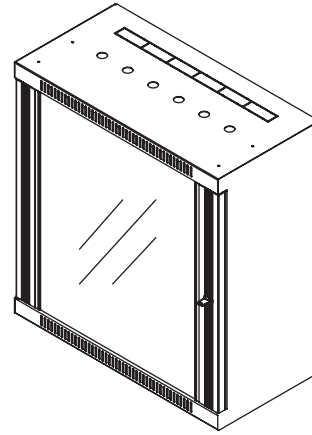

Isometric view

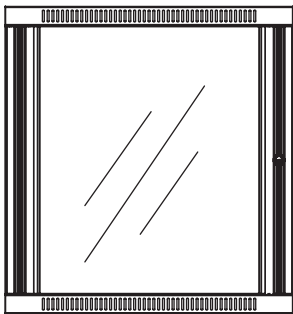

Front view

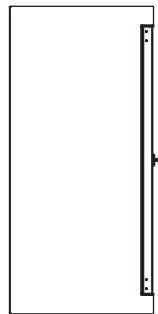

Side view

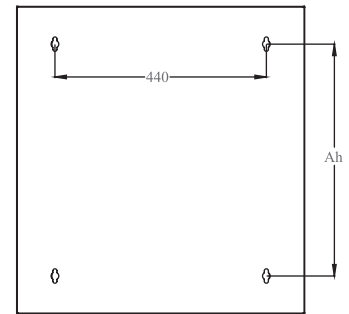

Rear view

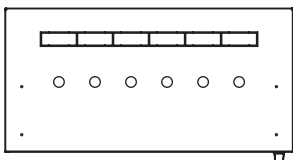

Top view

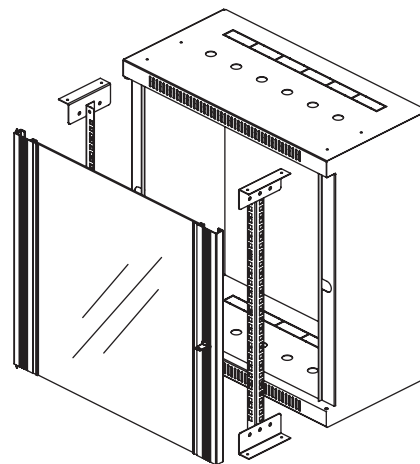

Exploded view

19" NETbox HOME Wall Mounting Cabinets

Width: 600 mm
Depth: 300 mm

Construction Drawing

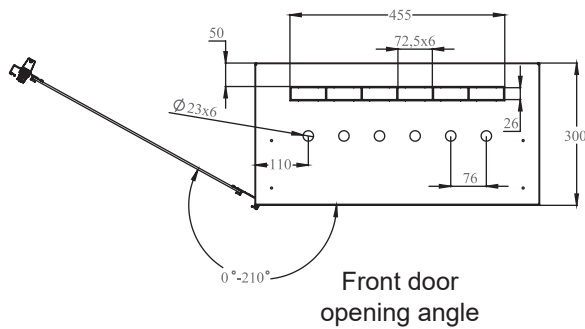

Front door opening angle

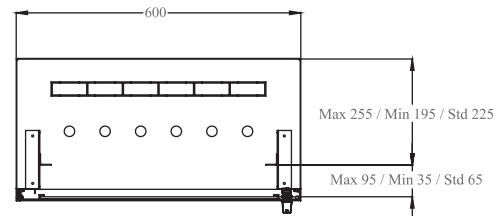

Max/Std/Min
Equipment mounting distance

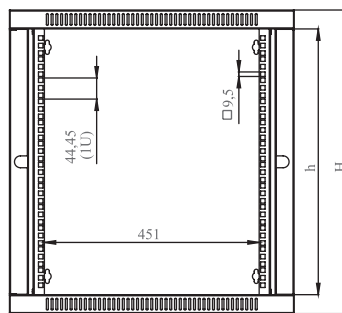

Dimensions in width and height

19" NETbox HOME Series Wall Mounting Cabinets W= 600 mm D= 300 mm

*Product Number	Product Description	Size WxDxH mm	h Size in U	h in mm	H mm, overall	Ah Wall Mounting h mm	Width Overall mm	Width Rail to Rear Door	Depth Overall mm	Depth Shipping Conf. Rail to Rear Panel mm	QTY IN PACKAGE	PACKING DIMENSIONS WxDxH mm	Standard NET Weight of Product kgs	Gross Weight of Product kgs	QTY IN PALLET	PALLET DIMENSIONS WxDxH mm	Pallet Weight kgs
LN-RS06U6030-LG	6U 19" Wall Mounting Cabinet W=600 mm D=300 mm	600x300x373	6U	267	373	215	600	19"	300	225	1	620x320x395	10	11	36	1100x1320x2460	421
LN-RS09U6030-LG	9U 19" Wall Mounting Cabinet W=600 mm D=300 mm	600x300x506	9U	400	506	349	600	19"	300	225	1	620x320x525	13	14,5	28	1100x1250x2380	426
LN-RS12U6030-LG	12U 19" Wall Mounting Cabinet W=600 mm D=300 mm	600x300x640	12U	533	640	482	600	19"	300	225	1	620x320x660	16	18	14	680x1250x2430	267

*CC= LG for Light Grey RAL 7035 & BL for Black RAL 9005 for customers to define while ordering.

19" NETbox Home Wall Mounting Cabinets

Frequent Used Accessorries



M6 steel caged nut set, screw and nuts included, 8 pcs set, 20 pcs set and 50 pcs set.

NETbox HOME Wall Mounting Cabinet Mounting Hardware		
Part Number	w:600 x d:150 mm	w:600 x d:300 mm
LN-DGR-KFS-M608-XX	✓	✓
LN-DGR-KFS-M620-XX	✓	✓
LN-DGR-KFS-M650-XX	✓	✓



Horizontal cable management panels are for the cable management inside the cabinet, with the intend of carrying the cables into the final connection point. 1U 19" with 5 rings. Supply is in RAL 9005 Black and RAL 7035 Light Grey colors.

NETbox HOME Wall Mounting Cabinet - Horizontal Cable Management		
*Part Number	w:600 x d:150 mm	w:600 x d:300 mm
LN-KDG-YKD-1UKN-CC	✓	✓

* CC is color code: please insert BL for Black and LG for Light Grey on the part numbers while creating order.



PDU 6xDIN49440 socket Schuko power strip, 19" 1U, aluminium housing, 1x16A cct breaker, 4000 Watt, 250V AC, 3x1.5mm², 2,5m cable, DIN 49441 plug, CE approval.

PDU 6xBS1363 UK socket power strip, 19" 1U, aluminium housing, 16A illuminated on/off switched, 3250 Watt, 250V AC, 3x1.5mm², 2,5m cable, 13A BS1363 plug, CE approval

NETbox HOME Wall Mounting Cabinet - Power Distribution Unit		
Part Number	w:600 x d:150 mm	w:600 x d:300 mm
LN-PRZ-SGT-1U6P-SC	✓	✓
LN-PRZ-ONF-1U6P-UK	✓	✓



VP Engineering
LANDE ENDUSTRIYEL METAL URUNLER SANAYI
LTD STI
Eskişehir Organize Sanayi Bölgesi
20.Cad. No:14
26110 TURKEY

Date: 2014/02/13
Subscriber: None
PartySite: 812185
File No: E465575
Project No: 14SR108002
PD No: 14M06415
Type: R
PO Number:

Subject: **Procedure And/Or Report Material**

The following material resulting from the investigation under the above numbers is enclosed.

Issue

<u>Date</u>	<u>Vol</u>	<u>Sec</u>	<u>Pages</u>	<u>Revised Date</u>
2014/01/31	1	1	Cert of Compliance	

Resending Certificate of Compliance per Clients request.

Inspections at your plant will be conducted under the supervision of STEVE GALLO, AREA MANAGER, UL INSPECTION CENTER N JERSEY/PHILLY, UL LLC, PO BOX 627, MILLTOWN, NJ, United States, 08850-0627., PHONE: 732-448-1513, FAX: 732-448-1625, EMAIL: STEPHEN.R.GALLO@US.UL.COM

Please file revised pages and illustrations in place of material of like identity. New material should be filed in its proper numerical order.

NOTE: Follow-Up Service Procedure revisions DO NOT include Cover Pages, Test Records and Conclusion Pages. Report revisions DO NOT include Authorization Pages, Indices, Section General Pages and Appendixes.

Please review this material and report any inaccuracies to PABLO CARDONA SANCHEZ (EXT. 586906)
This material is provided on behalf of UL LLC(UL) or any authorized licensee of UL.

MIL File

UL INSPECTION CENTER 114

CERTIFICATE OF COMPLIANCE

Certificate Number 20140213-E465575
Report Reference E465575-20140131
Issue Date 2014-FEBRUARY-13

Issued to: LANDE ENDUSTRIYEL METAL URUNLER SANAYI VE
TICARET LTD STI
Eskisehir Organize Sanayi Bölgesi
20.Cad. No:14
26110 TURKEY

**This is to certify that
representative samples of**

AUDIO/VIDEO, INFORMATION AND COMMUNICATION
TECHNOLOGY EQUIPMENT CABINET, ENCLOSURE
AND RACK SYSTEMS
IT Cabinet Systems, Model LN series (followed by
alphanumeric characters related to type and dimensions).

Have been investigated by UL in accordance with the
Standard(s) indicated on this Certificate.

Standard(s) for Safety:

UL 2416, Outline of Investigation for Audio/Video,
Information and Communication Technology Equipment
Cabinet, Enclosure and Rack Systems;
UL 60950-1 and CSA C22.2 NO. 60950-1-07, Information
Technology Equipment Safety Part 1: General
Requirements

Additional Information:

See the UL Online Certifications Directory at
www.ul.com/database for additional information

Only those products bearing the UL Listing Mark for the US and Canada should be considered as being covered by UL's Listing and Follow-Up Service meeting the appropriate requirements for US and Canada.

The UL Listing Mark for the US and Canada generally includes: the UL in a circle symbol with "C" and "US" identifiers:  the word "LISTED"; a control number (may be alphanumeric) assigned by UL; and the product category name (product identifier) as indicated in the appropriate UL Directory.

Look for the UL Listing Mark on the product.

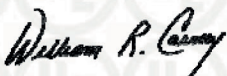

William R. Carney, Director, North American Certification Programs
UL LLC

Any information and documentation involving UL Mark services are provided on behalf of UL LLC (UL) or any authorized licensee of UL. For questions, please contact a local UL Customer Service Representative at www.ul.com/contactus





TÜRK STANDARDLARI ENSTİTÜSÜ
TÜRK STANDARDLARINA UYGUNLUK BELGESİ
TURKISH STANDARDS INSTITUTION
CERTIFICATE OF CONFORMITY TO TURKISH STANDARDS

Markanın Tanımı Description of the Mark
TSE veya/or TSE veya/or T S E

BELGE NUMARASI REFERENCE NUMBER OF LICENCE	066568-TSE-01/04
BELGENİN İLK VERİLİŞ TARİHİ DATE OF FIRST ISSUE OF LICENCE	13.12.2012
BELGENİN SON GEÇERLİLİK TARİHİ LICENCE VALID UNTIL	30.06.2022
BELGE SAHİBİ KURULUŞUN ADI NAME OF THE LICENCE HOLDER	LANDE ENDÜSTRİYEL METAL ÜRÜNLER SANAYİ VE TİCARET ANONİM ŞİRKETİ
BELGE SAHİBİ KURULUŞUN ADRESİ ADDRESS OF THE LICENCE HOLDER	SAFA MAH. ATATÜRK CAD. YAĞIZ SOK. NO:4 SANCAKTEPE/ İSTANBUL/TÜRKİYE
ÜRETİM YERİ ADI NAME OF THE MANUFACTURING PLACE	LANDE ENDÜSTRİYEL METAL ÜRÜNLER SANAYİ VE TİCARET ANONİM ŞİRKETİ
ÜRETİM YERİ ADRESİ ADDRESS OF THE MANUFACTURING PLACE	ESKİŞEHİR ORGANİZE SANAYİ BÖLGESİ 20.CAD. NO:14 26110 ESKİŞEHİR / TÜRKİYE
İPTAL EDİLEN BELGE NUMARASI (Varsa) INDICATION OF SUPERSEDED LICENCE (if any)	066568-TSE-01/03
TESCİLLİ TİCARİ MARKASI REGISTERED TRADE MARK	Lande
İLGİLİ TÜRK STANDARDI RELATED TURKISH STANDARD	TS EN 61587-1 / 23.03.2010
BELGE KAPSAMI SCOPE OF LICENCE	

-Sismik Dayanıklığı Olmayan, Dikili Tip Model: FS 13U-45U, DB 13U-45U, TX 13U-45U, Server Tip Model: DC 22U-45U, SRDC 22U-45U, Klimatik Sınıfı: C2, Endüstriyel Ortam sınıfı: A2, Statik Mekanik Yük Sınıfı (Kabinler): SL6, Dinamik Yük Sınıfı (Kabinler): DL4, Çarpma Sınıfı (Kabinler): K2, IP20, Boyutlar(mm): 13U 18U 22U 27U 31U 36U 40U 45U Derinlik: 300 (300 Dahil)den 1200'e(1200 Dahil) Genişlik: 550 (550 Dahil)den 900(900 Dahil)
-Sismik Dayanıklığı Olmayan, Duvar Tip Model: WM 1U-12U, PR 1U-12U, WX 1U-12U, Klimatik Sınıfı: C2, Endüstriyel Ortam sınıfı: A2, Statik Mekanik Yük Sınıfı (Kabinler): SL6, Dinamik Yük Sınıfı (Kabinler): DL4, Çarpma Sınıfı (Kabinler): K1, IP20, Boyutlar(mm): 1U,2U,3U,4U,5U,6U,7U,8U,9U,10U,11U,12U Derinlik: 300 (300 Dahil)den 1200'e(1200 Dahil) Genişlik: 550 (550 Dahil)den 900(900 Dahil)



e-imzalı/e-signed

03.12.2021

Belgelendirme Merkezi Başkanı Adına
Ahmet NAMLI

İzmir Belgelendirme Müdürü

*Bu belge, belgelendirilen ürünün, üretim yerinin Enstitümüzün belirlediği şartları karşıladığını da gösterir.

*Bu belge, hiç bir suretle tahrih edilemez, kısmen veya okunmasını zorlaştıracak şekilde çoğaltılamaz, kazıntı ve silinti yapılamaz.

*TSE İZMİR BELGELENDİRME MÜDÜRLÜĞÜ * Adres: 8780/1 sokak No:5 Çiğli /İZMİR * Telefon: 0232 376 24 25(3H) * Faks: 0 232 445 42 32

*TSE BELGELENDİRME MERKEZ BAŞKANLIĞI; Adres: Necatibey Cad. No:112 06100 Bakanlıklar/ANKARA – Telefon: 0 312 416 64 81 / 416 64 27, Faks:0 312 416 66 17 E-posta : bmb@tse.org.tr , web : www.tse.org.tr

